

# JSB-A12-75 (12V75Ah)



JSB-A12-75 is a general purpose battery with 10 years floating design life, meet with IEC, JIS .BS and Eurobat standard. With heavy duty grid, thickness plates, special additives, JSB-A series battery have long and reliable standby service life. Our JSB-A series batteries keep high consistent for better performance in series usage.



## Specification

Cells Per Unit	6
Voltage Per Unit	12
Capacity	75Ah@10hr-rate to 1.75V per cell @25°C
Weight	Approx. 23.5 Kg
Max. Discharge Current	750A (5 sec)
Internal Resistance	Approx. 6 mΩ
Operating Temperature Range	Discharge: -20°C~60°C Charge: 0°C~50°C Storage: -20°C~60°C
Normal Operating Temperature Range	25°C±5°C
Float charging Voltage	13.6 to 13.8 VDC/unit Average at 25°C
Recommended Maximum Charging Current Limit	22.5 A
Equalization and Cycle Service	14.6 to 14.8 VDC/unit Average at 25°C
Self Discharge	JALPOWER batteries can be stored for more than 6 months at 25°C. Self-discharge ratio less than 3% per month at 25°C. Please charge batteries before using.
Terminal	Terminal F11/F15
Container Material	A.B.S. (UL94-HB), Flammability resistance of UL94-V1 can be available upon request.



MH2839



G4M20206-0910-E-16



ISO9001:2000 Certificate

## Dimensions

Unit: mm Dimension: 260(L)×169(W)×235(H)

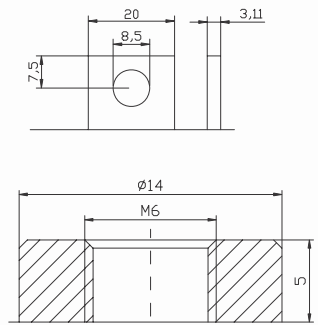
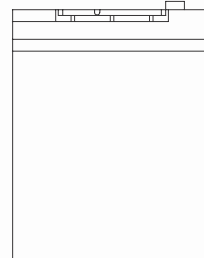
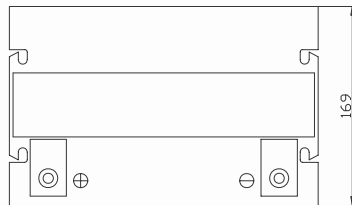
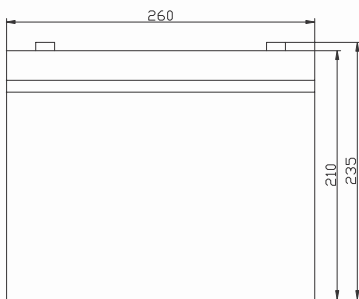

### Constant Current Discharge Characteristics: A (25°C)

F.V/Time	5MIN	10MIN	15MIN	30MIN	1HR	2HR	3HR	4HR	5HR	8HR	10HR	20HR
9.60V	262.08	192.96	140.40	86.250	48.750	27.232	19.575	16.200	13.260	9.3163	7.8772	4.1658
10.0V	254.51	183.60	137.52	84.825	48.525	27.027	19.500	16.125	13.182	9.2406	7.8015	4.0901
10.2V	246.96	177.12	135.36	84.075	48.075	26.822	19.350	16.050	13.104	9.1649	7.7257	4.0144
10.5V	221.76	163.44	128.88	81.975	47.625	26.618	19.275	15.900	12.948	9.0891	7.6500	3.9386
10.8V	200.16	149.04	118.80	78.375	46.500	26.140	18.750	15.525	12.714	8.9376	7.5743	3.8629
11.1V	174.24	133.20	106.56	73.425	44.175	24.980	17.925	14.775	12.168	8.5589	7.3470	3.6356

### Constant Power Discharge Characteristics: W(25°C)

F.V/Time	5MIN	10MIN	15MIN	30MIN	1HR	2HR	3HR	4HR	5HR	8HR	10HR	20HR
9.60V	2748.7	2051.9	1510.8	924.68	557.55	313.27	225.90	187.20	153.50	108.11	88.575	46.786
10.0V	2675.2	1959.8	1479.4	913.14	554.85	312.04	225.45	186.75	152.57	107.65	87.666	46.331
10.2V	2594.7	1894.5	1459.3	902.45	550.80	309.17	224.10	185.85	152.10	106.74	87.212	45.877
10.5V	2336.5	1750.6	1391.5	881.93	545.40	306.31	222.75	184.50	150.70	105.84	86.304	45.423
10.8V	2101.7	1589.5	1278.5	841.75	531.90	301.80	217.35	179.55	148.36	103.56	85.395	44.969
11.1V	1814.2	1411.6	1141.7	788.74	504.00	287.88	206.55	171.00	140.87	99.931	82.670	43.152

All mentioned values are average values.

### Effect of temperature on long term float life



### Storage characteristic

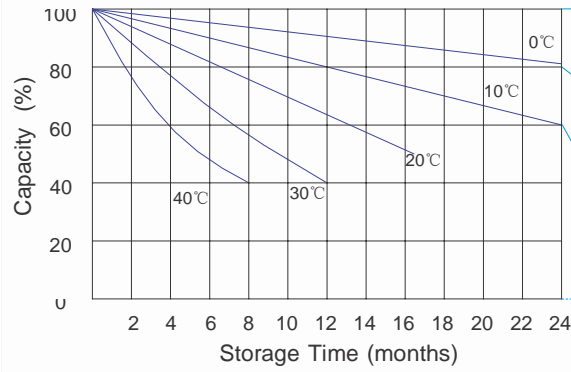

Supplementary charge required (Carry out supplementary charge requires)

Supplementary charge required  
This supplementary charge will help to recover the capacity and should be made as early as possible.

Supplementary charge may often fail to recover the capacity. The battery should never be left

Supplementary charge and storage guidelines

### Charge characteristic Curve for standby use

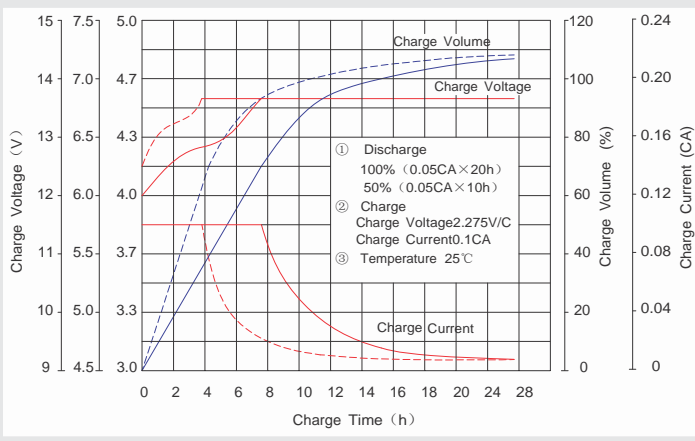

### Discharge characteristic Curve

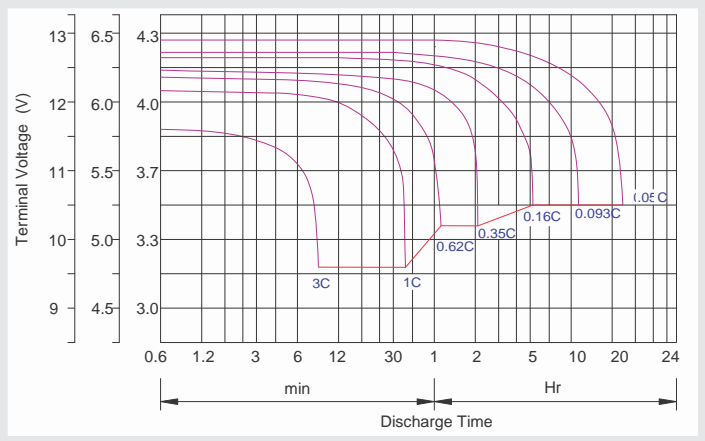

### Capacity Factors With Different Temperature

Battery Type		-20°C	-10°C	0°C	5°C	10°C	20°C	25°C	30°C	40°C	45°C
GEL Battery	6V&12V	50%	70%	83%	85%	90%	98%	100%	102%	104%	105%
	2V	60%	75%	85%	88%	92%	99%	100%	103%	105%	106%
AGM Battery	6V&12V	46%	66%	76%	83%	90%	98%	100%	103%	107%	109%
	2V	55%	70%	80%	85%	92%	99%	100%	104%	108%	110%

### Discharge Current VS. Discharge Voltage

Final Discharge Voltage V/cell	1.75V	1.70V	1.60V
Discharge Current (A)	(A) ≤ 0.2C	0.2C < (A) < 1.0C	(A) ≥ 1.0C

**Charge the batteries at least once every six months, if they are stored at 25°C.**

Charging Method:

Constant Voltage	-0.2Cx2h+2.4-2.45V/cellx24h, Max. Current 0.3CA
Constant Current	-0.2Cx2h+0.1CAx 12h
Fast	-0.2Cx2h+0.3CAx4.0h

### Maintenance & Cautions

<b>Float Service:</b>
※ Every month, recommend inspection every battery voltage.
※ Every three months, recommend equalization charge for one time.
Equalization charge method:
Discharge: 100% rate capacity discharge.
Charge: Max. current 0.3CA, constant voltage 2.4-2.45V/Cell charge 24h.
※ Effect of temperature on float charge voltage: -3mV/°C/Cell.
※ Length of service life will be directly affected by the number of discharge cycles, depth of discharge, ambient temperature and charging voltage.